

TYPE 1

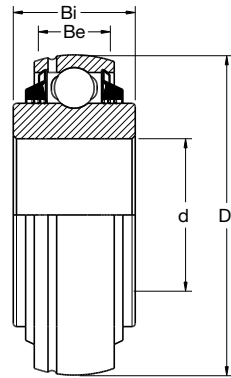

TYPE 2

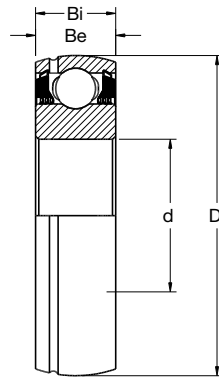

TYPE 3

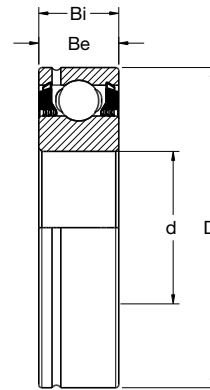

TYPE 4

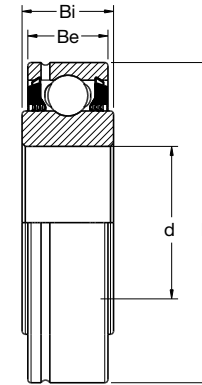

TYPE 5

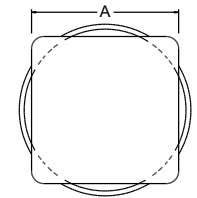

SQUARE BORE

ROUND BORE RELUBE

Part Number	Type	d		D		Be	Bi	Load Ratings		Wt. Lbs.
		nominal	mm	nominal	mm			Dynamic	Static	
GW209PPB2	3	1.7717	85.000	3.3465	85.000	1.1880	1.1880	7350	4150	1.44
GW209PPB4	3	1.5350	85.000	3.3465	85.000	1.1880	1.1880	7350	4150	1.65
GW209PPB11	1	1.7810	85.000	3.3465	85.000	0.8660	1.4380	7350	4150	1.37
GW210PPB2	3	1.9380	90.000	3.5433	90.000	1.1880	1.1880	7880	4650	1.50
GW210PPB5	3	1.7850	90.000	3.5433	90.000	1.1880	1.1880	7880	4650	1.80
GW210PP9	5	1.9450	90.000	3.5433	90.000	0.9060	1.4380	7880	4650	1.75
GW211PP2	4	2.1880	100.000	3.9370	100.000	1.3120	1.3120	9740	5850	3.00
GW211PPB2	3	2.1880	100.000	3.9370	100.000	1.3120	1.3120	9740	5850	2.62
GW211PPB8	1	2.1880	100.000	3.9370	100.000	0.9840	1.3120	9740	5850	1.85
GW211PPB9	1	2.1950	100.000	3.9370	100.000	0.9840	1.5620	9740	5850	2.02
GW211PPB10	3	1.9380	100.000	3.9370	100.000	1.3120	1.3120	9740	5850	2.26
GW211PPB13	1	1.7850	100.000	3.9370	100.000	0.9840	1.3120	9740	5850	2.02
GW211PPB14	1	2.0150	100.000	3.9370	100.000	0.9840	1.3120	9740	5850	2.00
GW211PP25	5	1.7800	100.000	3.9370	100.000	1.3120	1.7500	9740	5850	2.44
GW214PP2	4	2.7559	125.000	4.9213	125.000	1.5620	1.5620	14000	8800	4.19
GW214PPB2	3	2.7559	125.000	4.9213	125.000	1.5620	1.5620	14000	8800	3.96
GW214PPB3	3	1.9380	125.000	4.9213	125.000	1.5620	1.5620	14000	8800	4.24
GW214PPB5	2	2.7559	125.000	4.9213	125.000	1.5620	2.4380	14000	8800	4.75
GW214PPB6	1	2.6881	125.000	4.9213	125.000	1.1024	2.6875	14000	8800	5.14

SQUARE BORE RELUBE

Part Number	Type	d		A	D		Be	Bi	Load Ratings		Wt. Lbs.
		nominal	mm		nominal	mm			Dynamic	Static	
GW208PPB5	1	1.1250	80.0000	1.1800	80.0000	3.1496	0.8270	1.4380	7340	3650	1.47
GW208PPB6	1	1.0000	80.0000	1.0300	80.0000	3.1496	0.8270	1.4380	7340	3650	1.75
GW208PPB8	2	1.1250	80.0000	1.1800	80.0000	3.1496	1.1880	1.4380	7340	3650	1.75
GW208PP17	4	1.1250	85.7380	1.1800	85.7380	3.3755	1.1880	1.4380	7340	3650	2.04
GW208PPB17	2	1.1250	85.7380	1.1800	85.7380	3.3755	1.1880	1.4380	7340	3650	2.04
GW209PPB5	2	1.2500	85.0000	1.2900	85.0000	3.3465	1.1880	1.4380	7350	4150	1.75
GW209PPB8	1	1.2500	85.0000	1.2900	85.0000	3.3465	0.8660	1.4380	7350	4150	1.65
GW210PP4	5	1.1250	90.0000	1.1800	90.0000	3.5433	1.1880	1.1880	7880	4650	2.31
GW210PPB4	3	1.1250	90.0000	1.1800	90.0000	3.5433	1.1880	1.1880	7880	4650	1.75
GW211PP3	5	1.5000	100.0000	1.5311	100.0000	3.9370	1.3120	1.3120	9740	5850	2.79
GW211PPB3	3	1.5000	100.0000	1.5311	100.0000	3.9370	1.3120	1.3120	9740	5850	2.66
GW211PP5	4	1.5000	101.6000	1.5311	101.6000	4.0000	1.4380	1.7500	9740	5850	2.69
GW211PP17	4	1.5000	100.0000	1.5311	100.0000	3.9370	1.3120	1.7500	9740	5850	2.62
GW211PPB17	1	1.5000	100.0000	1.5311	100.0000	3.9370	1.3120	1.7500	9740	5850	2.55
GW212PP50	4	1.7500	110.0000	1.7400	110.0000	4.3307	1.5060	2.0000	11790	8110	4.35
GW214PPB4	3	2.0000	125.0000	2.0551	125.0000	4.9213	1.5620	1.5620	14000	8800	4.75
GW216PP2	4	2.2500	140.0000	2.3150	140.0000	5.5118	1.1810	2.5000	16280	10400	6.32

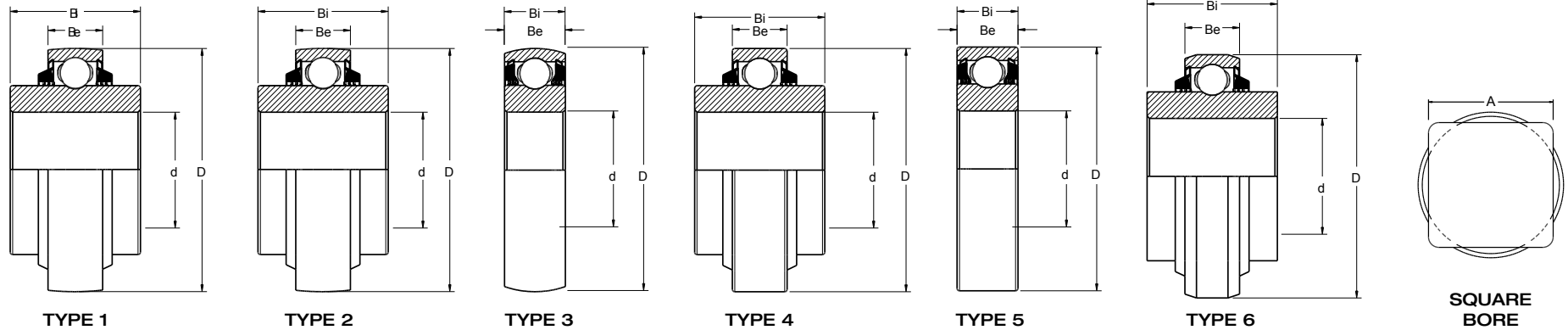

ROUND BORE NON-RELUBE									
Part Number	Type	d	D		Be	Bi	Load Ratings		Wt. Lbs.
		nominal	nominal	mm	nominal	nominal	Dynamic	Static	
W208PPB2	1	1.5005	3.1496	80.000	0.7090	1.6880	7340	3650	1.59
W208PPB7	2	1.1880	3.1496	80.000	0.7090	1.1880	7340	3650	1.41
W208PP10	4	1.5005	3.1496	80.000	0.8270	1.6880	7340	3650	1.50
W208PPB10	1	1.5005	3.1496	80.000	0.8270	1.6880	7340	3650	1.59
W208PPB23	2	1.5005	3.1496	80.000	1.1880	1.6880	7340	3650	1.50
W209PPB2	3	1.7717	3.3460	85.000	1.1880	1.1880	7350	4150	1.45
W209PPB4	3	1.5350	3.3460	85.000	1.1880	1.1880	7350	4150	1.65
W210PP2	5	1.9380	3.5433	90.000	1.1880	1.1880	7880	4650	1.69
W210PPB2	3	1.9380	3.5430	90.000	1.1880	1.1880	7880	4650	1.56
W210PPB5	3	1.7850	3.5430	90.000	1.1880	1.1880	7880	4650	1.75
W210PP8	5	1.5300	3.5433	90.000	1.1880	1.1880	7880	4650	1.97
W210PPB9	2	1.9448	3.5433	90.000	0.9055	1.4382	7880	4650	1.91
W211PP2	5	2.1880	3.9370	100.000	1.3120	1.3120	9740	5850	2.33
W211PPB2	3	2.1880	3.9370	100.000	1.3120	1.3120	9740	5850	3.00
W211PPB4	6	2.1880	3.9370	100.000	1.3120	2.1870	9740	5850	3.63
W214PP2	5	2.7559	4.9213	125.000	1.5620	1.5620	14000	8800	4.19
W214PPB2	3	2.7559	4.9213	125.000	1.5620	1.5620	14000	8800	3.96
W214PPB9	3	2.7660	4.9213	125.000	1.1020	1.7500	14000	8800	3.96

SQUARE BORE NON-RELUBE										
Part Number	Type	d	A	D		Be	Bi	Load Ratings		Wt. Lbs.
		Shaft Size	nominal	nominal	mm	nominal	nominal	Dynamic	Static	
W208PP5	4	1.1250	1.1800	3.1496	80.0000	0.7090	1.4380	7340	3650	1.50
W208PPB5	1	1.1250	1.1800	3.1496	80.0000	0.7090	1.4380	7340	3650	1.47
W208PP6	4	1.0000	1.0300	3.1496	80.0000	0.7090	1.4380	7340	3650	1.62
W208PPB6	1	1.0000	1.0300	3.1496	80.0000	0.7090	1.4380	7340	3650	1.59
W208PP8	4	1.1250	1.1800	3.1496	80.0000	1.1880	1.4380	7340	3650	1.66
W208PPB8	2	1.1250	1.1800	3.1496	80.0000	1.1880	1.4380	7340	3650	1.66
W208PPB9	2	1.0000	1.0300	3.1496	80.0000	1.1880	1.4380	7340	3650	1.74
W208PPB11	6	0.8750	0.9050	3.3760	85.7500	1.1880	1.4380	7340	3650	2.05
W208PPB12	6	1.1250	1.1800	3.3760	85.7500	1.1880	1.4380	7340	3650	1.62
W208PPB13	1	0.8750	0.9050	3.1496	80.0000	0.7090	1.4380	7340	3650	1.62
W209PPB5	2	1.2500	1.2900	3.3465	85.0000	1.1880	1.4380	7350	4150	1.75
W209PPB7	6	1.2500	1.2900	3.3760	85.7500	1.1880	1.4375	7350	4150	1.80
W210PP4	5	1.1250	1.1800	3.5433	90.0000	1.1880	1.1880	7880	4650	1.92
W210PPB4	3	1.1250	1.1800	3.5433	90.0000	1.1880	1.1880	7880	4650	2.11
W210PPB6	2	1.1250	1.1800	3.5433	90.0000	1.1880	1.4380	7880	4650	2.11
W211PP3	5	1.5000	1.5311	3.9370	100.0000	1.3120	1.3120	9740	5850	2.79
W211PPB3	3	1.5000	1.5311	3.9370	100.0000	1.3120	1.3120	9740	5850	2.66
W211PP5	4	1.5000	1.5311	4.0000	101.6000	1.4380	1.7500	9740	5850	3.38
W211PPB6	6	1.5000	1.5311	4.0770	103.5560	1.4380	1.7500	9740	5850	4.05

ROUND BORE				
Turner	Fafnir	BCA	Link-Belt	NTN
GW209PPB2	GW209PPB2	DS209TTR2	RG3-209E3	3AC09D1
GW209PPB4	GW209PPB4	DS209TTR4	24RG3-209E3	3AC09-1 1/2 D1
GW209PPB11	GW209PPB11	DS209TTR10		1AC09D1V1
GW210PPB2	GW210PPB2	DS210TTR2	31RG3-210E3	3AC10-1 15/16 D1
GW210PPB5	GW210PPB5	DS210TTR5R	28RG3-210E3	3AC10-1 3/4 D1
GW211PP2	GW211PP2	DC211TTR2	35RBG3-211E3	7AS11-1 1/2 D1
GW211PPB2	GW211PPB2	DS211TTR2	35RG3-211E3	3AC11-2 3/16 D1
GW211PPB8	GW211PPB8			
GW211PPB9	GW211PPB9	DS211TTR9		
GW211PPB13	GW211PPB13	DS211TTR13		
GW211PPB14	GW211PPB14			
GW211PP25	GW211PP37	DC211TTR21		
GW214PP2	GW214PP2	DC214TTR2		3AC14D1
GW214PPB2	GW214PPB2			
GW214PPB3		DS214TTR3		
GW214PPB5	GW214PPB5	DS214TTR5		
GW214PPB6		DS214TTRA		

SQUARE BORE				
Turner	Fafnir	BCA	Link-Belt	NTN
GW208PPB5	GW208PPB5	DS208TTR21	18SG7-2E08E3	1AS08-1 5/32 D1
GW208PPB6	GW208PPB6	DS208TTR6	16SG7-208E3	
GW208PPB8	GW2080PPB8	DS208TTR8	18SG2-2E08E3	2AS08-1 1/8 D1
GW208PP17	GW208PP17	DC208TTR17		
GW208PPB17	GW208PPB17			
GW209PPB5	GW209PPB5	DS209TTR5		
GW209PPB8	GW209PPB8	DS209TTR8	20SG5-209E3	
GW210PP4	GW210PP4	DC210TTR4	18SBG3-210E3	7AS10-1 1/8 D1
GW210PPB4	GW210PPB4	DS210TTR4	18SG3-210E3	
GW211PP3	GW211PP3	DC211TTR3	24SBG3-211E3	7AS11-1 1/2 D1
GW211PPB3	GW211PPB3	DS211TTR3	24SG3-211E3	3AS11-1 1/2 D1
GW211PP5	GW211PP5			
GW211PP17	GW211PP17	DC211TTR3E		
GW211PPB17	GW211PPB17			
GW214PPB4	GW214PPB4			3AS14-2D1
GW216PP2	GW216PP2	DC216TTR2		

ROUND BORE				
Turner	Fafnir	BCA	Link-Belt	NTN
W208PPB2	W208PPB2		24R6-208E3	2AC08-1 1/2
W208PPB7	W208PPB7	DS208TT7	19R208E3	1AC08-1 3/16
W208PP10	W208PP10	DC208TT10	24RB-208E3	
W208PPB10	W208PPB10			
W208PPB23	W208PPB23	DS208TT2A		
W209PPB2	W209PPB2	DS209TT2	R3-209E3	
W209PPB4	W209PPB4	DS209TT4	24R3-209E3	3AC09-1/2
W210PP2	W210PP2	DC210TT2	31RB3-210E3	7AC10-1 15/16
W210PPB2	W210PPB2	DS210TT2	31R3-210E3	3AC10-1 15/16
W210PPB5	W210PPB5	DS210TT5	28R3-210E3	3AC10-1 3/4
W210PP8	W210PP8			
W210PPB9	W210PPB9			
W211PP2	W211PP2	DC211TT2	35RB3-211E3	7AC11-2 3/16
W211PPB2	W211PPB2	DS211TT2	35R3-211E3	3AC11-2 3/16
W211PPB4	W211PPB4	DS211TT4		
W214PP2	W214PP2		W214PP2	
W214PPB2	W214PPB2		W214PPB2	

SQUARE BORE				
Turner	Fafnir	BCA	Link-Belt	NTN
W208PP5	W208PP5	DC208TT5	18SB5-2E08E3	5AS08-1 1/8
W208PPB5	W208PPB5	DS208TT5	18S5-2E08E3	1AS08-1 1/8
W208PP6	W208PP6	DC208TT6	16SB5-208E3	
W208PPB6	W208PPB6	DS208TT6	16S5-208E3	1AS08-1
W208PP8	W208PP8	DC208TT8	18SB2-2E08E3	6AS09-1 1/8
W208PPB8	W208PPB8	DS208TT8	18S2-2E08E3	2AS08-1 1/8
W208PPB9	W208PPB9	DS208TT9	16S2-208E3	2AS08-1 1/8
W208PPB11	W208PPB11	DS208TT11	14S4-208E3	4AS08-7/8
W208PPB12	W208PPB12	DS208TT12	18S4-2E08E3	4AS08-1 1/8
W208PPB13	W208PPB13	DS208TT13	14S5-208E3	1AS08-7/8
W209PPB5	W209PPB5	DS209TT5	20S2-209E3	2AS09-1 1/4
W209PPB7	W209PPB7	DS209TT7	20S4-209E3	
W210PP4	W210PP4	DC210TT4	18SB3-210E3	7AS10-1 1/8
W210PPB4	W210PPB4	DS210TT4	18S3-210E3	3AS10-1 3/4
W210PPB6	W210PPB6	DS210TT6	18S2-210E3	2AS10-1 1/8
W211PP3	W211PP3	DC211TT3	24SB3-211E3	7AS11-1 1/2
W211PPB3	W211PPB3	DS211TT3	24S3-211E3	3AS11-1 1/2
W211PP5	W211PP5	DC211TT5		6AS11-1 1/2 V1
W211PPB6	W211PPB6	DS211TT6		4AS11-1 1/2

SAE 52100 Inner Race, Outer Race and Rolling Elements.

52100 bearing steel is used for both inner and outer races. (Many competitors will use a lesser grade steel for the inner race.)

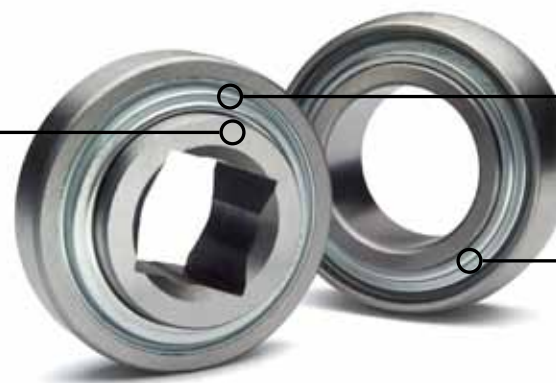

Triple Lip Seals.

Heavy triple lip seals are used for extra protection from the extremely dirty environment.

Steel Retainer

Steel retainers are used with all Turner Disc Harrow bearings which is the best retainer for heavy or shock loads.